

Technical Bulletin # 692D

General Guidelines

CHOCKFAST is an engineered epoxy chocking material that is used to cast-in-place permanent machinery supports for all sizes and types of main engines and marine auxiliary equipment. Because it conforms precisely to any surface profile, CHOCKFAST eliminates the machining of foundation and mounting surfaces as well as the fitting of the old-style steel chocks.

CHOCKFAST chocks must always be located around one or more machinery hold down bolts. Any thickness of chock can be cast. For ease of installation, 12mm to 45 mm (1/2" to 1-3/4") thick chocks work best.

Good chock design requires that all edges and corners of mounting pads and foundations penetrating the CHOCKFAST be rounded. Also, all grease, oil, mill scale, rust, flaking paint, burs, and welding slag must be removed. If necessary, a thin coat of inorganic zinc or epoxy primer may be applied to the machinery base and foundation to prevent rusting.

Selecting The Right Epoxy

There are two grades of CHOCKFAST used to mount marine machinery; CHOCKFAST ORANGE and CHOCKFAST GRAY. Selecting the right grade depends on the machinery's alignment requirements and the chock's normal operating temperature.

Precisely Aligned Equipment is equipment that cannot tolerate movement after installation greater than 0.127mm (0.005 inches) under static stresses of up to 3.4 N/mm² (500 psi). Examples of this class of machinery include main propulsion engines, and reduction gears.

Normal Operating Temperature is the temperature that the chocks will see during typical operating conditions and is usually equal to the temperature of the equipment mounting pads.

Where maintaining precise equipment alignment is required OR when the operating temperatures will typically be over 52°C (125°F), CHOCKFAST ORANGE must be used.

Where alignment does NOT have to be maintained precisely AND the operating temperature is below 52°C (125°F), CHOCKFAST GRAY may be used. Examples of this class of machinery include winches, pumps, skid mounted diesel generators and other self-contained equipment

The following instructions apply to normal CHOCKFAST installations on steel foundations where chock thickness is within the range shown in Table 1. For pours outside of this range, please contact ITW Polymer Technologies or one of its distributors.

Table 1: Standard Thickness of CHOCKFAST Pours

CHOCKFAST ORANGE	12 mm – 100 mm	½" – 4"
CHOCKFAST GRAY	12 mm – 50 mm	½" – 2"

Design Calculations – Precisely Aligned Equipment

1. The stress on the chocks due to the weight of the machinery is known as *Deadweight Loading*. Deadweight Loading may be limited by the vessel's classification society and must be determined prior to designing the chocks. Standard values for *Maximum Deadweight Loading* are from 0.7 N/mm² to 0.9 N/mm² (100 psi to 130 psi).
2. When designing precisely aligned chocks, first calculate the *Minimum Required Chock Area*. This is calculated by dividing the Total Machinery Weight (including water, oil, accessories, etc.) by the Allowed Deadweight Loading. Design the chocks to cover at least this minimum area and follow the General Guidelines for chock design. Remember that this is the MINIMUM area. Keep in mind that you may need to increase this area as you work through the calculations. The Actual Chock Area should be equal or greater than the Minimum Chock Area and be based on what is physically possible.

ITW POLYMER TECHNOLOGIES

130 Commerce Drive • Montgomeryville, PA 18936
Phone 215-855-8450 • Fax 215-855-4688 • www.chockfast.com



$$\frac{\text{Total Machinery Weight (N or lbs)}}{\text{Maximum Allowed Deadweight Loading (N/mm}^2 \text{ or lbs/in}^2\text{)}} = \text{Minimum Required Chock Area (mm}^2 \text{ or in}^2\text{)}$$

3. Next, find out the *Total Static Stress* allowed on the chocks by your classification society. *Total Allowed Static Stress* is the sum of *Deadweight Loading Stress* and the *Bolt Stress* caused by the tension on all mounting bolts. Chocks are typically designed to allow a maximum stress of 3.4 N/mm² (500 psi) on chocks for precisely aligned machinery. However, most classification societies approve a sliding scale of Static Stress vs. Chock Operating Temperature. For example, a number of societies approve 4.41 N/mm² (640 psi) at 80°C (176°F).

4. The *Total Allowable Bolt Stress* is what is left over after you subtract the *Actual Deadweight Loading* from the *Total Allowed Static Stress* given by your class society .

$$\frac{\text{Maximum Allowable Static Stress (N/mm}^2 \text{ or lbs/in}^2\text{)}}{\text{Actual Deadweight Loading (N/mm}^2 \text{ or lbs/in}^2\text{)}} = \text{Total Allowable Bolt Stress (N/mm}^2 \text{ or lbs/in}^2\text{)}$$

5. Multiply the *Total Allowable Bolt Stress* by the *Effective Chock Area* to get the *Maximum Chock Stress Allowed just due to Bolt Tension*. This is also known as *Total Bolt Tension* and is caused by all bolts holding the machinery in place. Then determine the individual *Tension per Bolt*, divide Total Bolt Tension by the number of bolts.

$$\frac{\text{Maximum Bolt Tension (N/mm}^2 \text{ or lbs/in}^2\text{)}}{\text{Actual Chock Area (mm}^2 \text{ or in}^2\text{)}} = \text{Total Bolt Tension (N or lbs)}$$

$$\frac{\text{Total Bolt Tension (N or lbs)}}{\text{Number of Bolts}} = \text{Tension per Bolt (N or lbs)}$$

6. To ensure the machine will not move, the Total Bolt Tension must total at least 2.5 times the machinery weight. To ensure the bolts stay tight, the Tension per Bolt divided by the cross sectional area of the bolt must be at least 46.3 N/mm² (6720 psi).

7. Finally, calculate the Bolt Torque required that will achieve this Bolt Tension. While there is no absolute relationship between tightening torque and bolt tension, there is a generally accepted formula for calculating bolt torque. Using one of the following formulas calculate the torque required to achieve that tension. As a check, torque and tension must be greater than the minimum values shown in Table 2.

$$\text{Torque (N.m)} = \frac{0.2 \times \text{Tension (N)} \times \text{Bolt Dia (mm)}}{1000}$$

$$\text{Torque (lbf.feet)} = \frac{0.2 \times \text{Tension (lbf)} \times \text{Bolt Dia (inches)}}{12}$$

Design Calculations – Non-Precisely Aligned Equipment

Chocks for equipment that do not require precise alignment can be made from either CHOCKFAST ORANGE OR CHOCKFAST GRAY.

In designing chocks for non-precisely aligned equipment, Deadweight Loading is not limited and, unless it is significant, need not be considered in the calculations. The primary consideration is the Total Continuous Static Stress on the chocks caused by the Bolt Tension. Bolt Tension is directly related to the Operational Loading of the equipment.

Operational Loading is the force applied to the equipment during its normal operation. For example, the load applied by the line on a capstan, the wire on a winch, the chain on a windlass, or the load on a crane. Operational Loading is classified into 3 groups by how frequently the load is applied: Continuous, Intermittent and Shock. The following table shows the Maximum Static Stress allowed on chocks used under non-precisely aligned machinery and equipment.

Table 3: Maximum Static Stress Allowed N/cm² (psi)

	Continuous	Intermittent	Shock
CHOCKFAST ORANGE	827 (1200)	2452 (3556)	6895 (10000)
CHOCKFAST GRAY	552 (800)	2000 (2900)	4000 (5800)

Static Stress on a chock is the sum of the engine deadweight and the tension on all bolts. The Total Bolt Tension on a piece of equipment may be increased up to a point where the Static Stress reaches either the Maximum Static Stress allowed in Table 3 above or where the Total Bolt Tension is equal to 80% of the Proof Load of the mounting bolt.

If you have any design questions or are in doubt regarding the design limits of the chocks under your equipment, please consult ITW Polymer Technologies or one of its distributors.

Table 2: Minimum Bolt Torque & Tension

Bolt Diameter (mm)	Minimum Torque (N.m)	Minimum Tension (N)	Bolt Diameter (inch)	Minimum Torque (ft.lbs)	Minimum Tension (lbs)
12	29	5,590	1/2	20	1320
14	39	7,551	5/8	30	2062
16	49	9,807	3/4	45	2970
18	69	12,503	7/8	75	4042
20	98	15,396	1	90	5279
22	118	18,633	1 1/8	126	6681
24	137	22,212	1 1/4	172	8248
27	157	29,077	1 3/8	230	9980
30	216	35,990	1 1/2	300	11877
33	294	44,571	1 5/8	380	13939
36	393	54,476	1 3/4	475	16166
39	491	62,861	1 7/8	580	18558
42	589	70,069	2	705	21115
45	736	81,738	2 1/8	845	23836
48	883	91,937	2 1/4	1005	26723
52	1080	103,754	2 3/8	1180	29775
56	1374	122,583	2 1/2	1375	32991
60	1669	138,911	2 5/8	1600	36373
64	1963	153,229	2 3/4	1830	39920
68	2454	180,266	2 7/8	2090	43631

NOTE: Table 2 is the **MINIMUM** desirable bolt tensions for various size bolts. **It is normally advantageous to use more than the minimum shown here.** When the bolt material is unknown, a safe Maximum Bolt Tension and Torque is 3 times the value given in this table.

Chock Design Example Calculations

There are six questions that must be answered when designing chocks for precisely aligned marine equipment. They are:

- 1) What is the Minimum Required Chock required?
- 2) What is the Tension allowed on each bolt?
- 4) Is this tension adequate to keep the bolts tight?
- 5) What torque is required to achieve this tension?
- 6) How much CHOCKFAST do I need?

The following example shows how these calculations are made for Precisely Aligned Equipment.

EXAMPLE – Chock Calculations for a Precisely Aligned Engine	
Equipment: Main Engine Weight: 75000 kg (165,347 lbs) Chocks: (10) 30 cm x 19.5 cm (11.8" x 7.7") (4) 32.5 cm x 19.5 cm (12.8" x 7.7") (4) 35 cm x 19.5 cm (13.8" x 7.7") Chock will be 35 mm (1.4") thick	Bolts: (18) M42 (1-5/8") Grade 8 Hold Down in 4.6 cm (1-7/8") hole (2) M45 (1-3/4") Grade 8 Fitted Bolts in 4.5 cm (1-3/4") holes (6) M38 (1-1/2") Jacking Bolts in 3.8 cm (1-1/2") holes
Per Class Society: Maximum Deadweight Loading = $0.9\text{N/mm}^2 = 90\text{N/cm}^2$ (130 psi) Maximum Total Static Stress = $4.41\text{N/mm}^2 = 441\text{N/cm}^2$ (640 psi)	
Initial Calculations: <ul style="list-style-type: none"> Determine the <i>Total Chock Area</i>. This includes the entire chock area under the machinery mounts. It does not include the overpour areas. NOTE: Dimensions were changed from millimeters to centimeters so the numbers would fit on this page. Determine the <i>Bolt Hole Area</i>. This is the area taken up by the bolt holes, jacking bolts and anything else that penetrates the chocks. Determine the <i>Effective Chock Area</i>. This is the actual chock area that supports the equipment. You get it by subtracting the Bolt Hole Area from the Total Chock Area. Convert the weight of the engine from Kg to N. Determine the <i>Actual Deadweight Loading</i>. The Actual Deadweight Loading must not exceed the Maximum Allowed Deadweight Loading. 	<ul style="list-style-type: none"> Total Chock Area = Quantity x Length x Width $(10) \times 30 \text{ cm} \times 19.5 \text{ cm} = 5,850 \text{ cm}^2$ [(10) x 11.8" x 7.7" = 907 in²] $(4) \times 32.5 \text{ cm} \times 19.5 \text{ cm} = 2,535 \text{ cm}^2$ [(4) x 12.8" x 7.7" = 393 in²] $(4) \times 35 \text{ cm} \times 19.5 \text{ cm} = \underline{2,730 \text{ cm}^2}$ [(4) x 13.8" x 7.7" = <u>423 in²</u>] $11,115 \text{ cm}^2$ $1,723 \text{ in}^2$ Bolt Hole Area = $\pi \times \text{Dia}^2 / 4$ (18) M42 - 4.6 cm dia holes = $3.14 \times 4.6^2 / 4 = 299 \text{ cm}^2$ (46.3 in²) (2) M45 - 4.5 cm dia holes = $3.14 \times 4.5^2 / 4 = 68 \text{ cm}^2$ (10.5 in²) (6) M38 - 3.8 cm dia holes = $3.14 \times 3.8^2 / 4 = \underline{32 \text{ cm}^2}$ (<u>5.0 in²</u>) 399 cm^2 (61.8 in²) Effective Chock Area = Total Chock Area – Bolt Hole Area Effective Chock Area = $11,115 \text{ cm}^2 - 399 \text{ cm}^2$ (1,723 in² – 61.8 in²) Effective Chock Area = $10,716 \text{ cm}^2$ (1,661.2 in²) $75,000 \text{ kg} \times 9.81 \text{ N/kg} = 735,750 \text{ N}$ (165,347 lbs) Actual Deadweight Loading = Engine Weight / Effective Chock Area $= 735,750 \text{ N} \div 10,716 \text{ cm}^2 = 68.7 \text{ N/cm}^2 < 70 \text{ N/cm}^2$ $(165,347 \text{ lbs} / 1,661 \text{ in}^2 = 99.5 \text{ psi} < 130 \text{ psi})$
Answers to the 6 Questions: <ol style="list-style-type: none"> <i>Minimum Required Chock Area</i> is the smallest amount of chock area that will support the engine adequately. It is found by dividing the Equipment Weight by the Maximum Deadweight Loading (N/cm²) allowed by your class society. Calculate the <i>Total Allowed Bolt Stress</i> by subtracting <i>Actual Deadweight Loading</i> from <i>Maximum Total Static Stress</i>. Now determine the <i>Total Bolt Tension</i> for the calculated amount of chock area by multiplying the <i>Total Allowed Bolt Stress</i> times the <i>Effective Chock Area</i>. This is the Tension on all the bolts. To determine <i>the Tension/Bolt</i>, divide the <i>Total Bolt Tension</i> by the number of hold down bolts. The <i>Total Bolt Tension</i> must be equal or greater than 2.5 times the weight of the equipment to ensure that the machinery will not move. The Tension per bolt must be at least 46.4 N per square mm (6720 psi) of bolt area to ensure the bolts will stay tight. Torque is calculated from the Bolt Tension and Bolt Diameter using one of the formulas in Paragraph 7 above. Calculate the Amount of Chockfast Required by first calculating the volume of each chock. Then calculate the volume of the overpour areas. Add these two volumes together and multiply by 1.1 to add 10% to the total to account for waste, spills, etc. Finally divide the total volume by the volume 	<ol style="list-style-type: none"> Minimum Required Chock Area = $735,750 \text{ N} / 70 \text{ N/cm}^2 = 10,511 \text{ cm}^2$ Because the Effective Chock Area (10,716 cm²), is larger than the minimum required chock area (10,522 cm²), the chocks do not have to be modified. If there wasn't enough area, the size of the chocks would have to be increased. Total Allowed Bolt Stress = $441\text{N/cm}^2 - 68.7 \text{ N/cm}^2 = 372.3 \text{ N/cm}^2$. This means the chocks can be loaded up to 372.3 N/cm² as a result of bolt stress created by tension on the mounting bolts. Total Bolt Tension = $372.3 \text{ N/cm}^2 \times 10,716 \text{ cm}^2 = 2,917,967 \text{ N}$. This is the sum of all bolt tensions on the chocks. Tension/Bolt = $2,917,967 \text{ N} / 20 \text{ Hold down bolts} = 145,898 \text{ N}$. The engine weighs 725,750 N. $2.5 \times 725,750 \text{ N} = 1,814,375 \text{ N}$. Total Bolt Tension is 2,917,967 N. Therefore, there is adequate bolt tension to make sure the engine will not move. The Bolt Area = $(\pi \times \text{Dia}^2) / 4 = (3.14 \times 42^2) / 4 = 1,385 \text{ mm}^2$ Bolt Tension per square mm = $145,898 \text{ N} / 1,385 \text{ mm}^2 = 105 \text{ N/mm}^2$. Because the Bolt tension per mm² is larger than 46.4 N/mm² the bolts will stay tight. Torque (N.m) = $(0.2 \times \text{Tension (N)} \times \text{Bolt Dia (mm)}) / 1000$. Torque = $(0.2 \times 145,898 \text{ N} \times 42 \text{ mm}) / 1000 = 1,226 \text{ N.m}$ Effective Chock Area = $10,716 \text{ cm}^2$ (1,661.2 in²) Chock Volume = $10,716 \text{ cm}^2 \times 3.5 \text{ cm thick} = 37,506 \text{ cm}^3$ (2,289 in³) Overpour Volume = Quantity x Chock Length x Overpour Width (1.2 cm average) x Overpour Depth (1.2 cm + Thickness of chock) $(10) \times 30 \text{ cm} \times 1.2 \text{ cm} \times 3.7 \text{ cm} = 1,332 \text{ cm}^3$ $(4) \times 32.5 \text{ cm} \times 1.2 \text{ cm} \times 3.7 \text{ cm} = 577 \text{ cm}^3$

of a unit of Chockfast to determine the number of units required.	$(4) \times 35 \text{ cm} \times 1.2 \text{ cm} \times 3.7 \text{ cm} = \frac{622 \text{ cm}^3}{}$ Overpour Volume = $2,531 \text{ cm}^3$ Total Volume = Chock Volume + Overpour Volume Total Volume = $37,506 \text{ cm}^3 + 2,531 \text{ cm}^3 = 40,037 \text{ cm}^3$ Add 10% for waste, spillage, etc. = $40,037 \text{ cm}^3 \times 1.1 = 44,041 \text{ cm}^3$ Number of 3.5 kg Units = $44,041 \text{ cm}^3 / 1,966 \text{ cm}^3 / \text{unit} = 23 \text{ units}$ Number of 6.8 kg Units = $44,041 \text{ cm}^3 / 4,261 \text{ cm}^3 / \text{unit} = 11 \text{ units}$
-------------------------------------------------------------------	------------------------------------------------------------------------------------------------------------------------------------------------------------------------------------------------------------------------------------------------------------------------------------------------------------------------------------------------------------------------------------------------------------------------------------------------------------------------------------------------------------------------------------------------------------------------------------------------

Instructions For Installing Chockfast

The following instructions apply to standard CHOCKFAST installations on steel foundations where the chock thickness is within the range specified in **Table 1: Standard Thickness of CHOCKFAST Pours**. Outside this range, please consult your CHOCKFAST distributor for guidance.

I. Materials Required

The following materials are required to effectively install CHOCKFAST chocks. Assemble all materials prior to starting any work.

- 1) CHOCKFAST: From the Chocking Plan, calculate the amount of CHOCKFAST required based on the following pre-packed units:

Table 4: Unit Sizes

Material	Units	Volume
CHOCKFAST ORANGE	3.4 kg (7.5 lbs)	1966 cm ³ (120 in ³)
	6.8 kg (15 lbs)	4261 cm ³ (260 in ³)
CHOCKFAST GRAY	5 kg (11 lbs)	3064 cm ³ (187 in ³)
	21.8 kg (48 lbs)	13372 cm ³ (816 in ³)

Always have an extra 10% to 15% available for chock thickness variation, waste, accidental loss, etc.

- 2) Damming Materials:
 - a) Flexible damming material such as open cell foam.
 - b) Metal front dam.
 - c) Putty, sealing or caulking compounds.
 - d) Contact adhesive for gluing foam sections together.
- 3) ITW Philadelphia Resins Release Agent.
- 4) Non-melt grease.
- 5) Variable –speed, heavy-duty electric hand drill capable of operating at speeds up to 200 rpm.
- 6) Jiffy mixing blade.
- 7) Surface thermometer.
- 8) Safety glasses or face shield.
- 9) Slitting knife
- 10) Hacksaw blade for cutting foam damming material.
- 11) Protective rubber gloves.
- 12) Epoxy solvent for cleanup. IMPAX IXT-59 or equal.
- 13) Plastic sheet or cardboard on which to mix the CHOCKFAST.

II Preparations

- 1) Create a Chocking Plan for your particular piece of machinery. Utilized the machinery manufacturer's mounting requirements and perform all the necessary calculations related to chock size and hold down bolt torque and tension. Determine exactly where the chocks will be positioned and what size they will be. Assemble all materials required by the plan. If necessary, have the Chocking Plan approved by the governing classification society prior to starting any work.
- 2) If the steel temperature is below 13°C (55°F), have sufficient heaters available to raise it above 15°C (60°F).

- 3) Store the resin and hardener at 20°C to 25°C (68°F to 77°F) for at least 12 hours but preferably 24 hours prior to use. This ensures the best mixing and pouring viscosity and the longest working time.
- 4) Round all corners and edges that may penetrate the CHOCKFAST.
- 5) Align the machinery and pour the CHOCKFAST with the vessel afloat. If alignment is critical, an adjustment should be made in the alignment to compensate for a slight settling that may occur of approximately 0.001cm per 1.0 cm (0.001 inch per 1 inch) of chock height.
- 6) Drill all bolt holes from the equipment bedplate down through the foundation as required by the equipment manufacturer.
- 7) Clean all surfaces that will come in contact with the CHOCKFAST. Surfaces should be free from oil, grease, water, rust, burrs, slag and loose paint. A thin coat of primer is acceptable.

III. Damming

The picture sequence below shows the general procedure for damming a mounting foot. Each installation will be different so follow the dimensions shown on the Chocking Plan for your particular machine.

- 1) Trim the foam damming material to the proper height allowing for a 6 mm (1/4 inch) crush on the foam. (A bare hacksaw blade works best for this.) This amount of crush will allow for easy foam installation but still hold the foam firmly in place. When a closed cell foam is used such as neoprene, air vent tubes must be glued intermittently along the top of the foam to allow the air to escape.
- 2) Insert the damming material under the equipment mounting plate and around the hold down bolts and jacking screws as described on your Chocking Plan. The foam damming material must be located on three sides of the chocks.
- 3) Seal the hold down bolts and bolt holes so they do not leak. If you remove the hold down bolts, insert tight-fitting wooden dowels into the holes. If the bolts are left in place, hand-tighten the nuts and wrap the bolt shank with Armaflex tubing. Coat whatever is used to core the hole with a heavy coating of non-melt grease.
- 4) Fitted bolts should be sprayed with ITW Polymer Technologies' Release Agent then installed.
- 5) With the side dams in place and the bolt holes filled and coated, spray the chock area with Release Agent. See Fig. 3
- 6) Install a front metal dam so that the width and height will be within the limits shown in the drawing below. Install by gluing in place, small pieces of foam to allow the CHOCKFAST to be poured higher than the bottom of the mounting foot. The overpour area is very important as it provides both head pressure to the underside of the mounting foot and a pool of molten CHOCKFAST to feed the chock area if

Fig. 1 Trim Foam to Proper Height

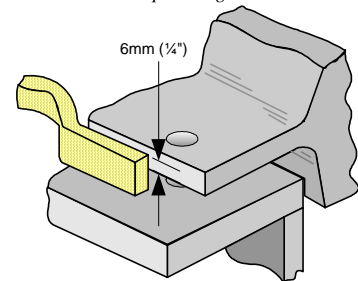

Fig. 2: Insert Damming per Chocking Plan

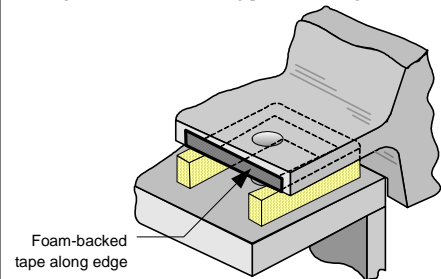

Fig. 3: Plug Bolt Holes (with well-greased plugs) Spray Chock Area with thin coat of Release Agent

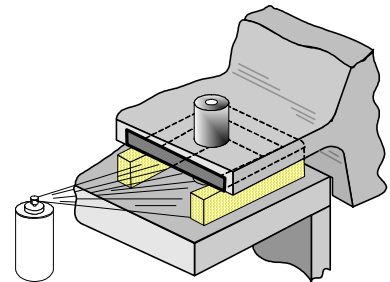
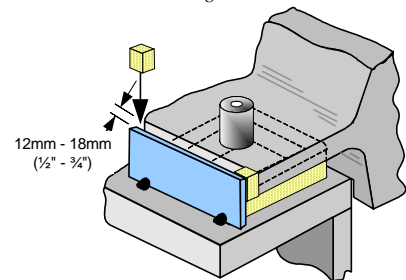

Fig. 4: Tack-Weld Front Dam & Insert Overpour Foam Damming at Each End



needed. See Fig. 4

- 7) Make sure all potential leak points are well sealed. It is much easier to prevent leaks before the resin is poured in than to stop them afterwards.
- 8) Spray the inside of the front metal dam with Release Agent so that it can easily be removed after the CHOCKFAST hardens. See Fig. 5.

IV Mixing And Pouring CHOCKFAST

- 1) Ensure that the damming completely surrounds the chock area and that there are no potential leak points.
- 2) Measure the chock thickness of each chock and the temperature of the engine bed and foundation. For CHOCKFAST ORANGE **only**, determine based on the graph in Fig. 9, how much hardener to use. The amount is based on machinery foundation temperature and the thickness of the chock. See Fig 6.

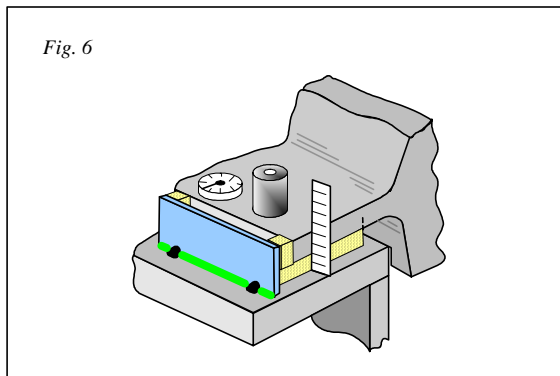

Fig. 6

- 3) Bring out the resin and hardener from storage.
- 4) Installing CHOCKFAST is usually a team effort. Assign someone to each of the following jobs:
 - a) open the boxes of CHOCKFAST for the mixers,
 - b) add the hardener and time the mixing
 - c) mix the CHOCKFAST,
 - d) pour the CHOCKFAST and inspect for leaks.
 Make sure each member of the team knows their job and have a backup plan if any of the mixing equipment should fail.
- 5) Make sure everyone working with CHOCKFAST puts on gloves and eye protection.
- 6) Add hardener to the resin as needed. Power mix at about 200 RPM (never more than 500 RPM) for 3 minutes using a Jiffy Mixing blade or equal. The mixer should be comfortably seated to hold the can of CHOCKFAST securely between the feet. Keep the blade submerged at all times and traverse the entire can. Make sure the bottom of the can is scoured. See Fig. 7.

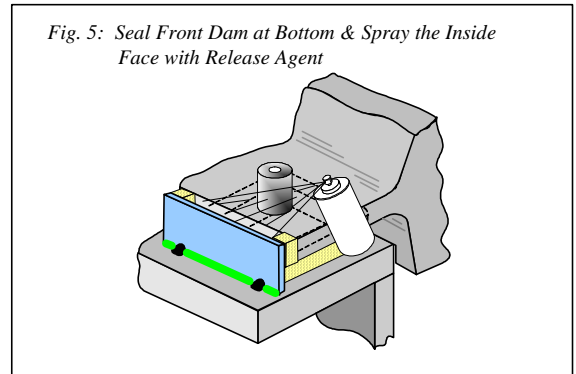

Fig. 5: Seal Front Dam at Bottom & Spray the Inside Face with Release Agent

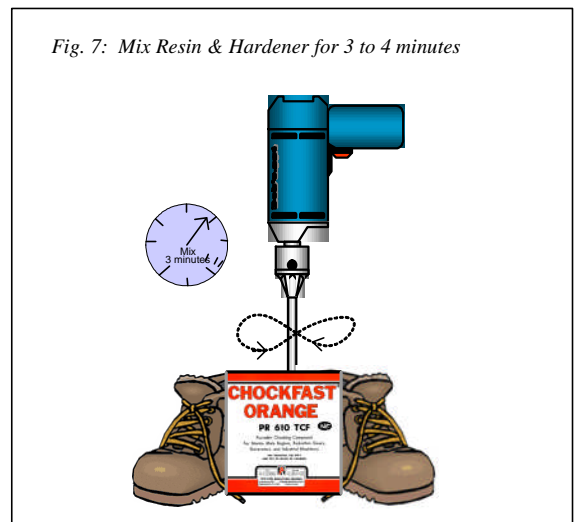

Fig. 7: Mix Resin & Hardener for 3 to 4 minutes

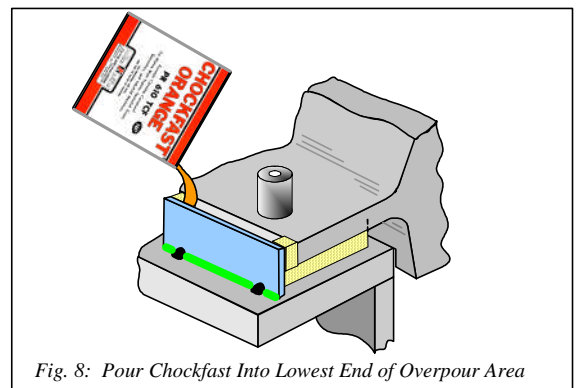
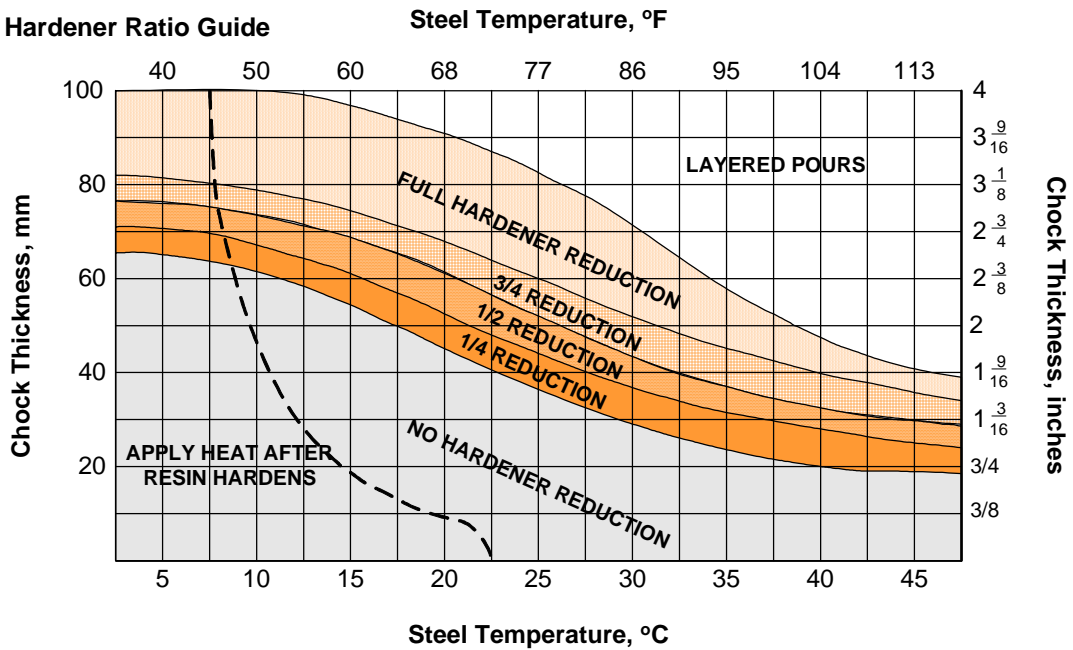

Fig. 8: Pour Chockfast Into Lowest End of Overpour Area

Fig.9 Hardener Ratio Guide



V After Pouring

- 1) Pour the resin as soon as possible after mixing. Do not scrape the residue from the can sides or bottom. Always pour from the lowest corner of the chock. Fill from a single point only so that air can escape as you fill. Pour as high above the chock as possible so that there is a thin ribbon of CHOCKFAST going into the chock. This forces any trapped air out of the liquid.
- 2) After Pouring Release the jack screws, alignment wedges or other alignment support devices.
- 3) In order for CHOCKFAST to cure, the temperature must be at least 13°C (55°F). Use heaters if necessary to bring the area up to at least this temperature. Length of cure will depend on temperature as follows:

13°C–18°C (55°F–65°F)	48 hours
19°C–21°C (66°F–70°F)	24 hours
Above 21°C (70°F)	18 hours
- 4) When curing is complete, remove heaters and allow the CHOCKFAST to return to ambient temperature.
- 5) Remove the front dams and grind off the sharp edges of the overpour.
- 6) Tighten the hold down bolts to the desired tension.

Reference

For design considerations and application details please request Bulletin No. XXX or contact ITW Polymer Technologies' Engineering Services Department.

Date

08/2005

<p>General: Every reasonable effort is made to insure the technical information and recommendations on these data pages are true and accurate to the best of our knowledge at the date of issuance. However, this information is subject to change without notice. Prior versions of this publication are invalid with the release of this version. Products and information are intended for use by qualified applicators that have the required background, technical knowledge, and equipment to perform said tasks in a satisfactory manner. Consult your local distributor for product availability, additional product information, and technical support.</p> <p>Warranty: ITW Polymer Technologies, a division of Illinois Tool Works Inc., warrants that its products meet their printed specifications. This is the sole warranty. This warranty expires one year after product shipment.</p> <p>Warranty Claims: If any product fails to meet the above, ITW Polymer Technologies will, at its option, either replace the product or refund the purchase price. ITW Polymer Technologies will have no other liability for breach of warranty, negligence, or otherwise. All warranty claims must be made in writing within one year of the date of shipment. No other claims will be considered.</p> <p>Disclaimer: ITW Polymer Technologies makes no other warranty, expressed or implied, and specifically disclaims any warranty of merchantability or fitness for a particular purpose.</p>	<p>Suggestions concerning the use of products are not warranties. The purchaser assumes the responsibility for determining suitability of products and appropriate use. ITW Polymer Technologies' sole liability, for breach of warranty, negligence or otherwise, shall be the replacement of product or refund of the purchase price, at ITW Polymer Technologies' election. Under no circumstances shall ITW Polymer Technologies be liable for any indirect, incidental or consequential damages.</p> <p>Modification of Warranty: No distributor or sales representative has the authority to change the above provisions. No change in the above provisions will be valid unless in writing and signed by an officer or the Technical Director of ITW Polymer Technologies. No term of any purchase order shall serve to modify any provision of this document.</p> <p>Mediation and Arbitration: If any dispute arises relating to products or product warranties, either the purchaser or ITW Polymer Technologies may a) initiate mediation under the then current Center for Public Resources (CPR) Model Procedure for Mediation of Business Disputes, or b) initiate a non-binding arbitration under the rules of the American Arbitration Association for the resolution of commercial disputes.</p>
----------------------------------------------------------------------------------------------------------------------------------------------------------------------------------------------------------------------------------------------------------------------------------------------------------------------------------------------------------------------------------------------------------------------------------------------------------------------------------------------------------------------------------------------------------------------------------------------------------------------------------------------------------------------------------------------------------------------------------------------------------------------------------------------------------------------------------------------------------------------------------------------------------------------------------------------------------------------------------------------------------------------------------------------------------------------------------------------------------------------------------------------------------------------------------------------------------------------------------------------------------------------------------------------------------------------------------------------------------------------------------------------------------------------------------------------------------------------------------------------------------------------------------------	---------------------------------------------------------------------------------------------------------------------------------------------------------------------------------------------------------------------------------------------------------------------------------------------------------------------------------------------------------------------------------------------------------------------------------------------------------------------------------------------------------------------------------------------------------------------------------------------------------------------------------------------------------------------------------------------------------------------------------------------------------------------------------------------------------------------------------------------------------------------------------------------------------------------------------------------------------------------------------------------------------------------------------------------------------------------------------------------------------------------------------------------------------------------------------------------------------------------------------------------------------------------------------------------------------------------------------